

ENGINEERING
TOMORROW

Danfoss

Installation guide

How to use **solenoid valves**
Making it **easy** to be efficient



ia.danfoss.com

How to use solenoid valves

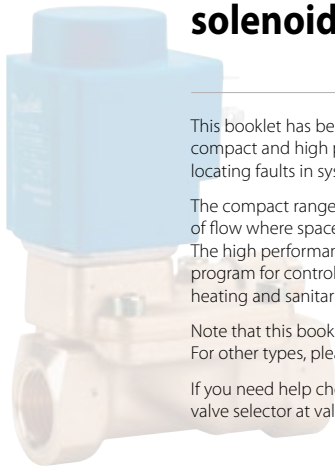

This booklet has been compiled to help in the installation of compact and high performance solenoid valves and in locating faults in systems with solenoid valves.

The compact range has small physical dimensions for control of flow where space is limited.

The high performance range is a sturdy and universal valve program for control of flow in industrial plants and within heating and sanitary systems.

Note that this booklet describes only brass solenoid valves. For other types, please contact Danfoss.

If you need help choosing a solenoid valve, visit the online valve selector at valveselector.danfoss.com

Flexible and user-friendly

Danfoss solenoid valve bodies and electrical coils are normally supplied separately and then combined together. They are assembled quickly and simply without any tools.

This provides optimum product flexibility and availability. If a coil needs replacement it can be done without stopping or draining any system.

The solenoid valves are also available as assembled units if required.

Contents

Identification	3
Installation.....	6
How to choose.....	13
Valve overview	18
Seal material	22
Coils.....	23
Opening and closing times.....	25
Fault location.....	27
Spare parts high performance range	32
Spare parts compact range.....	41
Tools.....	42

Choosing the correct solenoid valve



Symbolise valves used in a closed circuit system, typically with low differential pressures.

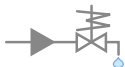

Symbolise valves used in an open system. Used typically for drinking water. Differential pressure higher than 0.5 bar.

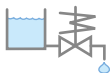

Symbolise valves used in a drain system.

Note! For more details see How to choose on page 13

Choosing the correct solenoid valve

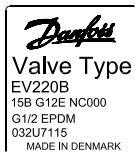

Illustration 1

Option 1: Identification using silver label (← 2011)

Illustration 1 shows the label with relevant information that is attached to the coil.

The example here is from an EV220B solenoid valve:

- 15: 15 mm orifice
- B: Brass body material
- G 12: ISO 228/1, 1/2 inch connection
- E: EPDM seal material
- NC: Normally closed

If the the coil label cannot be read, the valve can be identified from the letter/number combination stamped in the valve body.

Example:

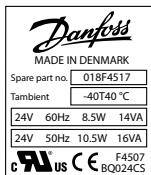
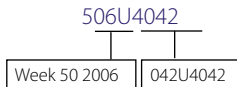

Illustration 2

The coil type (BQ024CS) is printed on the front of the coil as well as voltage (V) and frequency (Hz) - see illustration 2.

Option 2 (2011 →)

Printing on armature tube replaces silver labels and date / code no. stamping for identification of the valve.

Type Designation



EV220B	= Valve type
15	= 15 mm orifice
B	= Brass body material
G 12	= ISO 228/1, ½ inch connection
E	= EPDM seal material
NC	= Normally closed
667	= Options
BB230A	= Coil



Production Time

380	= Week 38 2010
032U711531	= Code Number



Note down following information

Valve code no.: _____

Sparepart no.: _____

Plug



018Z0081



042N0156

Valve identification problem

If above mentioned method is not possible, state the following when ordering Danfoss solenoid valves as replacements:

- Application (closed circuit, open system or drain application)?
- Function (Normally open or normally closed)?
- End connection?
- Medium (water, oil, air, etc.)?
- K_v value?
- Coil voltage?
- Alternating (AC) or direct current (DC)?

Flow direction

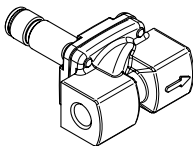

To be able to operate correctly, all solenoid valves must be installed with the arrow cast on the body pointing in the direction of flow.

Water hammer

Water hammer is a typical result of high liquid velocity (high pressure and high flow velocity through small pipe diameters).

There are several reasonable solutions to the problem:

1. Reduce the pressure by installing a pressure reduction valve ahead of the solenoid valve. If possible, increase the pipe diameter.
2. Damp the water hammer by installing a flexible hose or flexible buffer ahead of the solenoid valve.
3. Use a solenoid valve of the type EV220B 15 – EV220B 50. The equalizing orifice can be replaced by a version with smaller diameter. This gives a longer closing time (see “Spare parts” and “Opening and closing times”).

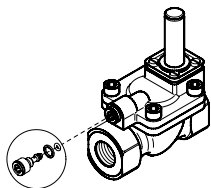

Equalizing orifice

Pipe

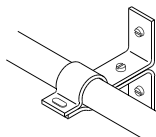

The pipes on both sides of the valve must be securely fastened.

Test pressure

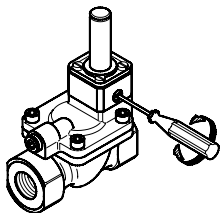

When applying test pressure: All valves in the system must be open. There are three ways of doing this:

1. By applying voltage to the coil
2. By opening the valves manually (when the manual override accessory is fitted)
3. By connecting the Danfoss permanent magnet (see "Tools", page 42)

Note that the manual opening unit is **not** supplied as standard, but as an accessory for EV220B 15 – EV220B 50 valves (see page 33).

Remember to screw the opening unit back (CLOCKWISE) before starting up the system, otherwise the valve cannot close.

Tightening up

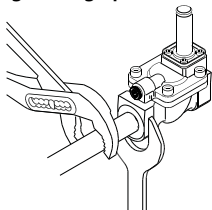

Always use counter-force when tightening up pipe connections, i.e. use a spanner on both the valve body as well as on the pipe connector (as shown).

Dirt in the system

Always flush out piping before installing a solenoid valve. If there is dirt in the medium, a filter should be installed ahead of the valve.

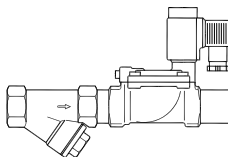

Installing the coil

Danfoss recommends that the solenoid valve be installed with coil upwards. This minimises the risk of dirt collecting in the armature tube.

If "clean" media is used, i.e. media containing no dirt particles, the solenoid valve will operate when installed in the orientation as shown below.

Servo-operated and assisted lift servo-operated valves

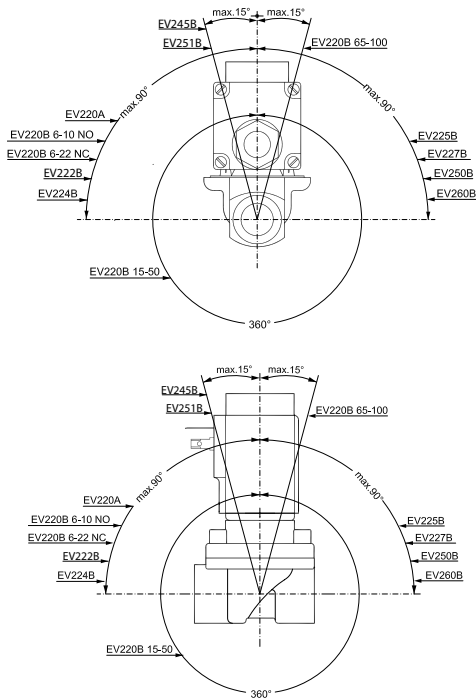

Direct-operated valves

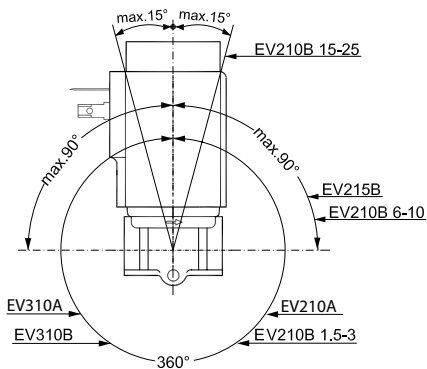
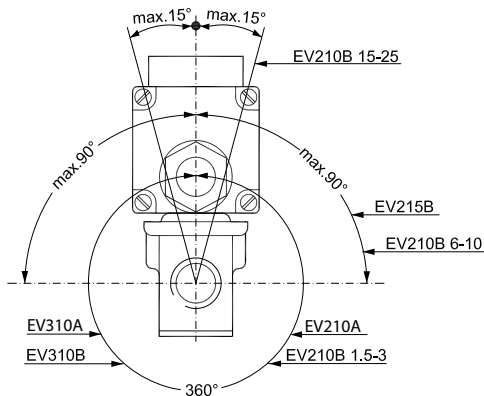

Coil

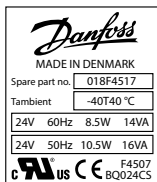

Check to ensure that the coil operating voltage is correct (see text on coil, in "Volt"). Also ensure that the data is correct (voltage and frequency) and matches the supply. If the two sets of data do not correspond, the coil might burn out. As far as possible, always choose single-frequency coils; they give off less heat than double-frequency versions.

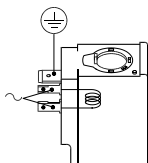

The coil has three pins. The middle pin is marked according to the illustration (left) and must be used for earthing. The two other pins are coil terminals and either can be used for the phase or neutral supply. The terminals can be used respectively for phase and neutral as required.

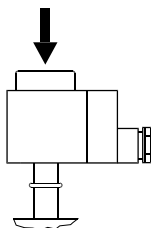

Please note for high performance range!
When mounting the clip-on coil, simply press it gently onto the armature, until it clicks into place. An O-ring should be fitted over the armature tube before fitting the coil.

Cable entries must always be screwed in correctly.

Cable connection

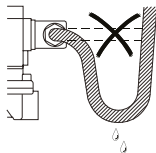

The cable must be installed as shown in the illustration to avoid water running into the terminal box.

Cable

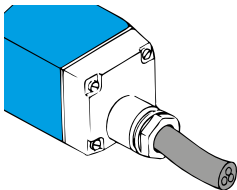

To avoid moisture penetrating in the terminal box, the whole cable diameter must be secured in the entry. For this reason, always use round cables as they are the only type that can be effectively sealed.



Note the colours on the cable leads. Yellow/green is always earth. The other leads should be for the phase and neutral supply.

Coil replacement

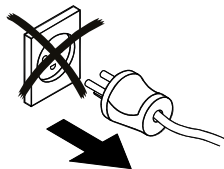

Please note for clip-on coils:

When replacing a coil, use a screwdriver to lever it from the armature.

Caution: Before removing a coil, voltage must be disconnected, otherwise the coil will burn out.

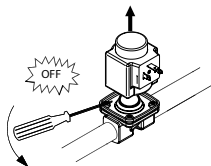

Product selection made easy for installers

With only a few clicks Danfoss Product Selector can help you find the right product for standard applications.

The tool is developed to help wholesalers, retailers, installers and the end user to clarify their needs within solenoid valves.

With Danfoss' web based tool, you can access anywhere; from your laptop or smartphone, as long as you have internet acces.

In the solenoid valve selector you only need to know 5 things:

- 1 Medium
- 2 System
- 3 Function
- 4 Connection size
- 5 Coil voltage

The Danfoss selector then presents a result for you which can be sent to your email, SMS or be printed out.

Danfoss though recommends OEM-customers, which typically get customized products for their applications, to contact their Danfoss distributor.

See how easy it is:

<http://valveselector.danfoss.com/>



*"Scan me with your
smartphone"*

If you do not have internet access try identify all relevant parameters.

This includes:

- 1 Capacity / K_V - value
- 2 Pressure conditions
- 3 Media conditions
- 4 Other conditions

Capacity / K_V - value:

- 1 Specifies how many **m³/hour** (capacity) water is passing through the valve at a differential pressure at **1 bar**.
- 2 Is a result of all the different constants coming from shape of orifices, units etc. which are reduced to one new constant, the k_v - value.
- 3 Is used to calculate capacity:
- 4 ρ = density (kg / m³)
- 5 $\Delta P = P_1 - P_2$

$$Q = K_V \sqrt{\frac{\Delta P}{\rho}} \text{ [m}^3 \text{ / h]}$$

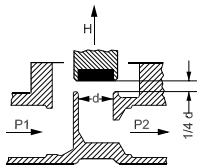

Pressure conditions

Open system (system with drain)

In an open system the pressure conditions are well-defined.

This enables clarification as to whether there is sufficient pressure differential to be able to open a servo-operated valve. The following types of valves are well-suited for use in open systems:

- EV210B and EV310B direct-operated solenoid valves
- EV220B, EV220A and EV225B servo-operated solenoid valves

Closed circuit (circulating system)

In a closed circuit system the pressure conditions are undefined. Therefore a solenoid valve capable of opening without pressure differential is required.

- EV250B assisted lift servo-operated valve
- EV210B and EV310B direct-operated solenoid valves

Operating pressure

Valves in the standard range are designed for pressure of max 6–30 bar – the actual figure depends on the type of valve.

The product range includes valves for special application, designed for pressures of up to 80 bar. The large standard range combined with these valves enable the use of Danfoss solenoid valves for all types of systems, whether with normal or more extreme inlet pressures.

Differential pressure/ MOPD

- 1 Difference between inlet pressure and outlet pressure ($\Delta P = P_1 - P_2$).
- 2 Max. permissible differential pressure against which the valve can open
- 3 Also specified as MOPD: **M**aximum **O**pening **P**ressure **D**ifferential
- 4 MOPD specifies the differential pressure value in worst case:
 - 100 % duty rate
 - Maximum medium and ambient temperature
 - Nominal voltage, typically -10%
- 5 Specified pressure is often limited by endurance demands more than MOPD

Media conditions

The valves are designed to resist the temperatures normally found in industrial applications.

If the temperature is outside these limits, there is a risk of the valve not functioning correctly because of, for example, rubber materials becoming hard. Exceeding the temperature rating can also result in the shortening of valve life. If the valve is to be used in a special application, with a temperature in excess of the rated limits, there are valves available in the product range which have been designed for use in higher temperature systems.

The characteristics of the medium

The valves have been designed for use with different media.

In general the following is valid:

Valves containing EPDM-rubber are suitable for water and steam*.

Valves containing FKM-/NBR-rubber are suitable for oil and air.

Incorrect use of valve types:

- 1 If a valve containing EPDM-rubber is used for a medium containing oil (compressed air normally contains particles of oil from the compressor) the rubber will expand and the valve will not be able to function optimally.
- 2 A valve containing FKM-/NBR-rubber can be used for water. However for servo-operated valves, the water temperature must be kept below 60 °C for FKM, 90 °C for NBR. If this temperature is exceeded it will have a negative effect on the life of the valve.

Other media

For slightly aggressive media (e.g. demineralised water) dezincificationresistant brass valves must be used. Stainless steel valves are used for more aggressive media.

**For steam temperatures above 120 °C there is a type of valve especially designed for steam*

Ambient temperature

The ambient temperature must be within certain limits for the coil to function optimally. See data sheet for coils.

Water hammer

All piping systems with relatively high flow rates are susceptible to water hammer when a valve is opened or closed. A damped solenoid valve (eg. EV220B 15–50) should be used if there is a risk of water hammer. After installation the valve can be adjusted for water hammer by changing a replaceable equalizing orifice. See "Spareparts" page 32.

Filter

In systems with contaminated media there is a risk of moving parts in a valve not working as intended. Dirt is the most common cause of function failure in solenoid valves. To help avoid this problem we suggest the fitting of a filter on the upstream side of the valve.

Coil voltage and power













It is necessary to know which voltage (Volt AC/DC nominal $\pm 10\%$) is available within an application to select the correct coil. The maximum permissible differential pressure can also be increased by fitting a more powerful coil. The coil power depends on the type of coil (BA, BB, AM etc.).

Other environmental factors

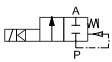

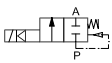
In wet or very humid environments, coils with IP67 enclosure classification must be used.

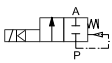
Valve function

Most industrial systems operate with a de-energised closed valve (NC = normally closed). Our valve range also offers de-energised open valves (NO = normally open) for applications requiring this feature.

		Medium			
		Air and neutral gasses	Water	Oil	Steam
EV210B 		✓	✓	✓	
					
EV310B 		✓	✓	✓	
					
EV220B 		✓	✓	✓	
					
EV250B 		✓	✓	✓	✓
					
EV225B BQ coil 					✓
					

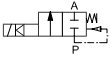
Characteristics		Description
Connection [ISO 228/1]	Function	
G 3/8" - G 1"	NC/NO	EV210B covers a wide range of direct-operated 2/2-way solenoid valves for universal use. EV210B is a real robust valve program with high performance and can be used in all kind of tough working conditions.
G 1/8" - G 3/8"	NC/NO	EV310B is a direct-operated 3/2- way solenoid valve. The valve is especially used in connection with air-operated valves to allow air supply and air relief for the air actuator.
G 1/4" - G 1"	NC/NO	EV220B 6–22 is a direct servo-operated 2/2-way solenoid valve program. This program is especially for OEM applications demanding a robust solution and moderate flow rates.
G 1/2" - G 2"	NC/NO	EV220B 15–50 is a universal indirect servo-operated 2/2-way solenoid valve program. Valve body in brass, dezincification resistant brass and stainless steel ensures that a broad variety of applications can be covered.
G 3/8" - G 1"	NC	EV250B with assisted lift is especially to use in closed circuits with low differential pressure, but demanding moderate flow rates. Valve body in DZR brass ensures a long life, even in connection with aggressive steam media.
G 1/4" - G 1"	NC	The EV225B design is based on a PTFE diaphragm and valve body in dezincification resistant brass, ensuring high reliable function and long life even in connection with contaminated steam.

		Medium			
		Air and neutral gasses	Water	Oil	Steam
EV220A 		✓	✓	✓	✓
					

Characteristics		Description
Connection [ISO 228/1]	Function	
G 1/4" - G 2"	NC	EV220A is a compact indirect servo-operated 2/2 way solenoid valve program with brass valve body for robust industrial application.
G 1/4" - G 1"	NO	

Media table

Medium \ Seal material [°C]	EPDM ¹⁾	FKM	NBR	PTFE
Water / glycols	- 30 – 140	0 – 60 0 – 100*	-10 – 90	-
Oil	-	0 – 100	-10 – 90	-
Air	-	0 – 100	-10 – 90	-
Steam	up to 140	-		up to 185

* Direct-operated valves

¹⁾

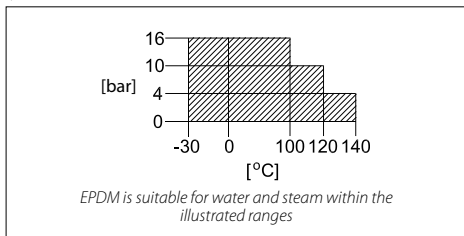

Coil consumption	Supply voltage / frequency ¹⁾	Code number
BB coils (IP65)		
10 W without cable plug	220 – 230 V AC / 50 Hz	018F7351
10 W without cable plug	110 V AC / 50-60 Hz	018F7360
10 W without cable plug	24 V AC / 50 Hz	018F7358
18 W without cable plug	24 V AC	018F7397
Cable plug for BB coils		042N0156

BE coil (IP67)		
10W with terminal box	220 – 230 V AC / 50 Hz	018F6701
10W with terminal box	115 V AC / 50 Hz	018F6711
10W with terminal box	48 V AC / 50 Hz	018F6709
10W with terminal box	24 V AC / 50 Hz	018F6707
18W with terminal box	24 V AC	018F6757

BG coils (IP67)		
20 W with terminal box	24 V AC	018F6857

BQ coil		
10W without cable plug	230 V AC / 50 Hz	018F4511
10W without cable plug	110 V AC / 50 Hz	018F4519
10W without cable plug	24 V AC / 50 Hz	018F4517
Cable plug for BQ coils		042N0156

For installations sensitive to noise

BN coil (hum-free, IP65)		
20 W with 1 m cable	220 – 230 V AC / 50-60 Hz	018F7301

¹⁾ For other voltages or coil types, see coil data sheet.

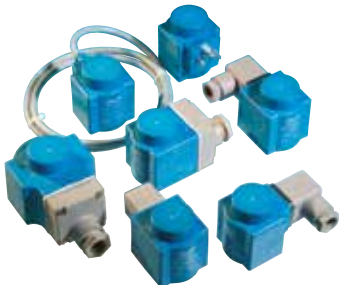

Coil consumption	Supply voltage / frequency ¹⁾	Code number
AM coils (IP00-IP65)		
7.5 W without cabel plug	110 V AC / 50/60 Hz	042N0845
7.5 W without cabel plug	220–230 V AC / 50/60 Hz	042N0840
9.5 W without cabel plug	24 V DC	042N0843
Cable plug for AM coils		042N0156

¹⁾ For other voltages or coil types, see coil data sheet.



Closing times and water hammer

With the larger valves, very short closing times can cause water hammer.

The EV220B servo-operated valves have damped closing and fulfil EN60730-2-8 specifications.

The table gives the opening/closing times of the various types, but it must be emphasised that tube dimensions / lengths and differences in operating conditions - especially pressure - can cause deviations from the values given.

High performance (blue) range

Type	Opening [ms]	Closing [ms]
EV210B 1.5	10	20
EV210B 3	20	20
EV210B 6	20	20
EV250B 12	100	100
EV250B 18	150	100
EV250B 22	150	100
EV220B 10	50	300
EV220B 12	60	300
EV220B 15	40	350
EV220B 20	40	1000
EV220B 25	300	1000
EV220B 32	1000	2500
EV220B 40	1500	4000
EV220B 50	5000	10000
EV310B 2	10 – 20	10 – 20

Compact (black) range

Type	Opening [ms]	Closing [ms]
EV220A 6	40	250
EV220A 10	50	300
EV220A 12	60	300
EV220A 14	100	400
EV220A 18	200	500
EV220A 22	200	500
EV220A 32	2500	4000
EV220A 40	4000	6000
EV220A 50	5000	10000

Changing opening and closing times

Please note for high performance type. EV220B 15 – EV220B 50 closing times can be changed by replacing the equalizing orifice at the inlet side of the valve (see "Water hammer" page 17, and "Spare parts" page 32). To decrease water hammer, choose a smaller equalizing orifice.

The table shows the opening and closing times depending on the equalizing orifice chosen (standard times marked in bold). The times stated cover water as a medium, and are for guidance only. Tube dimensions / lengths and operating conditions, for example differential pressure, may influence the values.

Orifice		EV220B 15		EV220B 20		EV220B 25		EV220B 32		EV220B 40		EV220B 50	
mm	Grooves	Open	Close	Open	Close	Open	Close	Open	Close	Open	Close	Open	Close
0.5	1	0.04	0.35	0.04	1.0	0.11	3.0	1.6	6.0	1.3	8.0	3.4	40.0
0.8	2	0.04	0.3	0.04	0.5	0.3	1.0	1.0	2.5	1.5	4.0	3.6	11.0
1.2	3	0.04	0.12	0.04	0.25	0.30	0.5	1.2	1.0	1.5	2.0	5.0	10.0
1.4	4	0.04	0.1	0.06	0.18	0.30	0.4	1.0	0.8	2.0	1.5	5.2	6.5

Symptom: Solenoid valve does not open

Probable cause	Remedy
No voltage on coil	Check whether valve is de-energised open or closed (NO or NC): 1. Use a magnetic detector 2. Lift coil slightly and note whether it offers resistance against lifting Note: Never remove a coil with voltage applied - it may burn out. Check relay contacts. Check lead connections. Check fuses.
Incorrect voltage / frequency	Check to make sure the coil's electrical requirements are the same as the installation supply. Measure the operating voltage at the coil. Permissible voltage variation: $\pm 10\%$ for dual frequency; DC and NO applications $+10\% / -15\%$ for AC on single frequency voltages If necessary, replace coil with correct version.
Coil burnt out	See page 31.
Diff. pressure too high	Check coil data. If necessary, replace coil with correct version. Reduce differential pressure, e.g. by limiting inlet pressure.
Diff. pressure too low	Check coil data and differential pressure. If necessary, replace coil with correct version.
Damaged / bent armature tube	Replace valve.
Dirt at diaphragm ²⁾	Clean diaphragm. If necessary, replace defective component(s) ¹⁾ .
Dirt in valve seat / dirt in armature / armature tube ²⁾	Clean valve; if necessary, replace defective component(s).
Corrosion	Replace defective component(s) ¹⁾ .
Components missing after valve dismantling	Fit missing component(s) ¹⁾ .

¹⁾ See "Spare parts" page 32

²⁾ If there is repeated build up of dirt in the armature / armature tube, consider the installation of an isolating diaphragm kit, if applicable (see "Spare parts" page 32)

Symptom: Solenoid valve partly opens

Probable cause	Remedy
Differential pressure too low	Check valve data, incl. differential pressure. Replace valve with correct version.
Damaged or bent armature tube	Replace valve.
Dirt at diaphragm	Clean diaphragm. If necessary, replace defective component(s) ¹⁾ .
Dirt in valve seat / dirt in armature / armature tube ²⁾	Clean valve, if necessary, replace defective component(s).
Corrosion	Replace defective component(s) ¹⁾ .
Components missing after valve dismantling	Fit missing component(s) ¹⁾ .

¹⁾ See "Spare parts" page 32

²⁾ If there is repeated build up of dirt in the armature / armature tube, consider the installation of an isolating diaphragm kit, if applicable (see "Spare parts" page 32)

Symptom:

Solenoid valve does not close/partly closes

Probable cause	Remedy
Voltage remains on coil	First lift coil slightly and note whether it offers resistance. Note: Never remove a coil with voltage applied - it might burn out. Check wiring diagram and wiring. Check relay contacts. Check lead connections.
Dirt in or closed pilot orifice / equalizing piece	Clean orifice with needle or similar (max. dia. 0.5 mm). Blow clean with compressed air. If necessary, replace defective component(s).
Manual opening unit cannot be screwed back after use.	Check position of opening unit and adjust as necessary.
Pulsation in pressure line. Differential pressure too high in open position. Pressure on outlet side periodically higher than pressure on inlet side.	Check valve data. Check pressure and liquid flow. Replace valve with one more suitable. Check rest of installation.
Damaged / bent armature tube	Replace valve.
Defective valve plate, diaphragm or valve seat	Check pressure and liquid flow. Replace defective component(s) ¹⁾ .
Diaphragm upside down	Check correct installation of valve ¹⁾ .
Dirt in valve seat/dirt in armature tube	Clean valve; if necessary, replace defective components.
Corrosion, pilot / main orifice	Replace defective components.
Valve installed wrong way round	Check liquid flow direction and make sure the arrow is pointing in the same direction.
Components missing after valve dismantling	Fit missing component(s) ¹⁾ .

¹⁾ See "Spare parts" page 32

Symptom:**Solenoid valve making noise**

Probable cause	Remedy
Hum	Hum caused by AC frequency can be removed by changing to coil with rectifier (see page 23).
Water hammer when valve opens Water hammer when valve closes	See "Installation".
Differential pressure too high and / or pulsation in pressure line	Check valve data and differential pressure. Check pressure and liquid flow. Replace with more suitable valve. Check rest of installation.

Symptom: **Coil burnt - cold with voltage on**

Probable cause	Remedy
Incorrect voltage / frequency	Check coil data. If necessary, change to correct coil type. Check wiring diagram and wiring. Check maximum voltage variation: Permissible voltage variation: ±10% for dual frequency; DC and NO applications +10% / -15% for AC on single frequency voltages
Coil short-circuit (could be moisture in coil)	Check rest of installation for possible short-circuiting. Check lead connections at coil. When fault has been found, replace coil. (See also "Coil" in section "Installation"). Consider fitting a 'clip-on' style coil with additional sealing O-ring (for high performance range only).
Armature sluggish 1) Damaged / bent armature tube 2) Damaged armature 3) Dirt in armature tube	Replace defective component(s). Remove dirt.
Temperature of medium too high	Check valve and coil data in relation to installation specification. Change to suitable coil or valve.
Ambient temperature too high	If possible, move valve to colder surroundings. Check valve and coil data in relation to installation specification. Increase ventilation around valve and coil.

Normally open components (NO)

The set contains locking button and nut for coil, normally open assembly kit (armature and armature tube) and an O-ring.

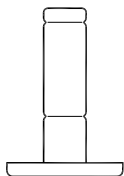

Type	Code number	
	FKM seal material ¹⁾	EPDM seal material ¹⁾
EV210B 1.5 – EV210B 4.5 NO	032U2004	032U2005
EV220B 6 NO	032U0166	032U0165
EV220B 10 NO	032U0167	-
EV220B 15 – EV220B 50 NO	032U0295	032U0296

NO components are also available for Danfoss valves with other seal materials.

¹⁾ See page 22 for description of seal materials

Manual override unit tool operated

The manual opening unit for EV220B 15 – EV220B 50 can be used to open and close the valve in the event of power failure or when applying test pressure.

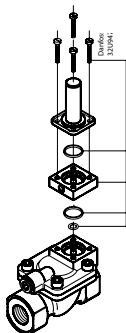

Material	Media temperature [°C]	Code number
Brass, size DN 15–32, seal NBR	-10 – 90	032U0150
Brass, size DN 40–50, seal NBR	-10 – 90	032U0260
Stainless steel, seal NBR	-10 – 90	032U0149



Manual override unit hand operated

Used for manual override in event of power failure.

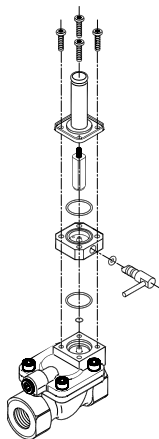

Material	Media temperature [°C]	Code number
Stainless steel, seal EPDM	-30 – 120	032U7390



Spare parts set for EV210B NC

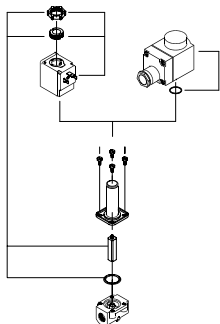

The spare parts set contains:

Locking button
Nut for coil
Armature with valve plate and spring
O-rings

EPDM versions

Type	Code number
EV210B 6, EV210B 8, EV210B 10	032U2006

FKM versions

Type	Code number
EV210B 1.5 – EV210B 4.5	032U2003
EV210B 6, EV210B 8, EV210B 10	032U2011

¹⁾ See page 22 for description of seal materials

Isolating diaphragm kit for EV210B 1.5 – EV210B 4.5 NC and EV220B 15 – EV220B 50 NC

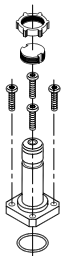

Avoids build up of contaminants that can block movement of the armature. Permits use of more aggressive media that would normally attack the armature. Gel filled; guarantees operation after long periods on inactivity.

Seal material	Media temperature [°C]	Code number
EPDM ¹⁾	-20 – 50	042U1009
FKM ¹⁾	0 – 50	042U1010

¹⁾ See page 22 for description of seal materials

Spare parts set for EV220B 6 – EV220B 12 NC

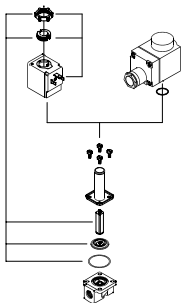

The spare parts set contains:

Locking button
Nut for coil
Armature with valve plate and spring
Diaphragm
2 O-rings

EPDM versions

Valve type	Code number
EV220B 6 NC	032U1062
EV220B 10 NC	032U1065
EV220B 12 NC	032U1068

Spare parts sets are also available for Danfoss EV220B valves with other seal materials (see page 22 for description of seal materials)

Spare parts set for EV220B 15 – EV220B 50

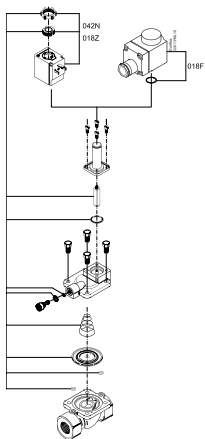

The spare parts set contains:

Locking button and nut for the coil
 Armature with valve plate and spring
 O-ring for the armature tube
 Spring and diaphragm
 2 O-rings for the pilot system
 O-ring and gasket for the equalizing orifice
 Equalizing orifice

Type	Seal material	Code number
EV220B 15	EPDM ¹⁾	032U1071
EV220B 20	EPDM ¹⁾	032U1073
EV220B 25	EPDM ¹⁾	032U1075
EV220B 32	EPDM ¹⁾	032U1077
EV220B 40	EPDM ¹⁾	032U1079
EV220B 50	EPDM ¹⁾	032U1081

Spare parts sets are also available for Danfoss EV220B valves with other seal materials.

¹⁾ See page 22 for description of seal materials

Equalizing orifice



The kit comprises:

An equalizing orifice includes 2 O-rings. The valves closing time can be changed by installing an equalizing orifice of a size which deviates from the standard valve:

- A shorter closing time is obtained with a larger orifice (the shorter closing time, the greater risk of water hammering)
- A longer closing time is obtained with a smaller orifice.

See also "Opening and closing times", page 25.

Equalizing orifice size [mm]	Seal material	Applicable in	Code number
0.5	EPDM ¹⁾	EV220B 15 EV220B 20	032U0082
0.8	EPDM ¹⁾	EV220B 25 EV220B 32 EV220B 40	032U0084
1.2	FKM ¹⁾	EV220B 25 EV220B 32	032U0085
1.2	EPDM ¹⁾	EV220B 50	032U0086
1.4	FKM ¹⁾	EV220B 40 EV220B 50	032U0087

Equalizing orifice sets are also available for Danfoss EV220B valves with other seal materials.

¹⁾ See page 22 for description of seal materials

**Spare parts set for
EV250B 12 –
EV250B 22 NC
EPDM seal material**

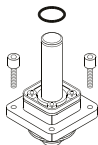

The spare parts kit comprises:

1. O-ring for coil
2. 4 screws
3. Complete NC actuator unit with diaphragm, assist spring, armature, closing spring, cover and armature tube

Valve type	Code number
EV250B 10 – EV250B 12 BD	032U5315
EV250B 18 – EV250B 22 BD	032U5317

**Spare parts set for
EV250B 12 –
EV250B 22 NC
FKM seal material**

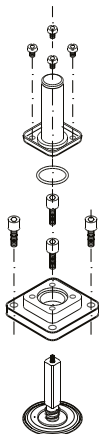

The spare parts kit comprises:

1. O-ring between armature tube and cover
2. Service element consisting of an armature with valve plate and spring fitted on the diaphragm

Valve type	Code number
EV250B 10 – EV250B 12 BD	032U5271
EV250B 18 – EV250B 22 BD	032U5273

Spare parts set for EV250B 12 – EV250B 22 NO

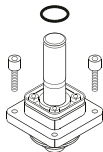

The spare parts kit comprises:

1. O-ring for coil
2. 4 screws
3. Complete NO actuator unit with diaphragm, assist spring, NO armature unit and cover

Valve type	Seal material	Code number
EV250B 10 – EV250B 12 BD	EPDM	032U5319
EV250B 18 – EV250B 12 BD	FKM	032U5320
EV250B 10 – EV250B 22 BD	EPDM	032U5321
EV250B 10 – EV250B 22 BD	FKM	032U5322

Spare parts kit for EV310B

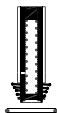

The spare parts kit comprises:

Armature with mounted spring

Type	Seal material	Code number
NC	FKM	032U2033
NO	FKM	032U2035

Spare parts kit for EV225B 6 – EV225B 25

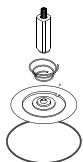

Spare parts kit for EV225B comprises:

Armature with valve plate and spring
Closing spring
Diaphragm
O-ring

Type	Code number
EV225B 6 – EV225B 10	032U3171
EV225B 15	032U3172
EV225B 20 – EV225B 25	032U3173

Coil for BQ high performance steam valve



Coil consumption [W] AC	Supply voltage [V]/ frequency [Hz]	Code number
10	230 / 50	018F4511
10	24 / 50	018F4517
10	110 / 60	018F4519

Spare parts kit for EV220A 6 – EV220A 50 NC



Spare parts kit comprising:

Armature assembly
Diaphragm assembly
Armature spring
Diaphragm spring
2 O-rings

Type	Seal material	Code number
EV220A 6 – EV220A 10 B	EPDM	042U1000
EV220A 6 – EV220A 10 B	NBR	042U1001
EV220A 6 – EV220A 10 B	FKM	042U1002
EV220A 12 – EV220A 14 B	EPDM	042U1003
EV220A 12 – EV220A 14 B	NBR	042U1004
EV220A 12 – EV220A 14 B	FKM	042U1005
EV220A 18 – EV220A 22 B	EPDM	042U1006
EV220A 18 – EV220A 22 B	NBR	042U1007
EV220A 18 – EV220A 22 B	FKM	042U1008
EV220A 32 B	EPDM	042U1037
EV220A 32 B	NBR	042U1038
EV220A 32 B	FKM	042U1046
EV220A 40 B	EPDM	042U1039
EV220A 40 B	NBR	042U1040
EV220A 40 B	FKM	042U1047
EV220A 50 B	EPDM	042U1041
EV220A 50 B	NBR	042U1042
EV220A 50 B	FKM	042U1048

Magnetic field indicator

This handy key ring tool reacts to magnetic fields from solenoid valves. Place the indicator close to the coil, and the red-white disc will prove the coil to be active by rotating.



Permanent magnet

With this tool it is possible to operate solenoid valves without wiring up the electrical coil.

Please contact your local Danfoss office to obtain these popular tools.



ENGINEERING
TOMORROW

Danfoss

How to use **solenoid valves** Making it **easy** to be efficient